

## FINANCIAL LITERACY IN THE MILLENNIUM GENERATION

Amanda Latifah<sup>1</sup>, Rosalia Nansih Widhiastuti<sup>2\*</sup>, Faizah Syihab<sup>3</sup>

<sup>1</sup>Student Faculty of Economics and Business, Management Program, University of Trilogi

<sup>2,3</sup>Lecturer, Faculty of Economics and Business, Management Program, University of Trilogi.

\*Corresponding author, e-mail: nansih@trilogi.ac.id

### Abstract

Financial literacy is defined as a person's understanding and knowledge of financial concepts or risks, as well as their skills, beliefs, and motivation in making effective financial decisions, participating in the economy, and improving their financial well-being. The purpose of this study is to determine the level of financial literacy in the millennial generation in Bogor, Depok, Tangerang, and Bekasi City using the Structural Equation Modelling (SEM) method and statistical software AMOS 24. The data used is primary data, and the sample size is 200 respondents. Locus of Control, Financial Knowledge, Financial Behaviour, Financial Attitude, and Financial Literacy are the variables examined in this study. According to the findings of this study, Locus of Control, Financial Behaviour, and Financial Attitude can all be used to assess Financial Literacy. The Locus of Control variable generates an  $R^2$  value of 55.8%, Financial Behaviour is 46.4%, and Financial Attitude is 27.4%. This demonstrates that these three variables can and do contribute to measuring the millennial generation's financial literacy. Meanwhile, Financial Knowledge cannot measure Financial Literacy, implying that the millennial generation in this study has poor financial knowledge, necessitating further research.

**Keywords:** *Financial Literacy, Locus of Control, Financial Knowledge, Financial Behaviour, Financial Attitude, Millennial.*

### 1. Introduction

Financial fluctuations have become a part of the transmission medium for the movement of economic and social activities aimed at improving people's lives. The financial sector in Indonesia is also one of the sectors that contributes significantly to the country's Gross Domestic Product (GDP). Although not by much, only about 5%, this sector can have an impact on other sectors (Jasindo, 2017). Many financial service institutions today will assist the public in gaining access to or using financial service institutions' services (Wicaksono, 2013).

According to a 2016 survey conducted by the Financial Services Authority (OJK), financial literacy in Indonesia remains at 29.7%. This means that the general public's understanding of the financial sector remains very low. Financial literacy has even been declared a national program in several countries to help people become financially literate, which will ultimately increase the nation's prosperity and welfare.

According to OJK, Indonesians are becoming more consumptive and are abandoning their savings habits. The decrease in the Marginal Propensity to Save (MPS) from 0.87 in 2007 to 0.44 in 2014 reflects this. This means that people spend their money on consumption rather than savings.

Financial literacy, also known as basic financial literacy, is a person's basic understanding of finance, including how a person manages his finances, such as saving, investing, borrowing, and spending.

The level of public understanding of financial literacy will be a critical provision for a family or individual to make financial decisions that will increase their financial resources and encourage access to the financial system.

Financial literacy benefits not only consumers but also financial institutions, because when people or individuals understand financial industry products, they are more likely to purchase one. Saving at the bank, borrowing money at the bank, insurance, investment, and so on (Stabilitas, 2016).

With the advancement of the times, humans are required to think smartly. Financial intelligence is a tool used to assess a person's ability to understand the importance of planning and implementing good financial governance (Senior Vice President, Head of Wealth Management Citibank, 2015).

According to Central Statistics Agency (BPS) population projection data, Indonesia's population in 2017 is dominated by productive groups, namely those aged 15-39 years, with a total of around 84.75 million of Indonesia's total population of 285 million, implying that the millennial generation now accounts for around 32% of Indonesia's population. One of the issues that the millennial generation may face in the next 5-10 years is that expenditure exceeds income, as evidenced by millennial habits such as eating out or shopping at malls. This generation is thought to prioritize short-term matters. when compared to the long term. As a result, they should be taught financial literacy at a young age, such as how to protect themselves with insurance and invest as capital to build a better future for themselves, their families, and the Indonesian economy, according to Pohemian (Director of PT Sequis Aset Manajemen, 2017).

DKI Jakarta is Indonesia's capital city, and it has a number of satellite cities. Sujatmiko (2014) defines a satellite city as a city on the outskirts of a larger city that is socially, economically, politically, and administratively dependent on the larger city. Bogor, Depok, Tangerang, and Bekasi, also known as BoDeTaBek, are DKI Jakarta's satellite cities. As cities close to DKI Jakarta, the centre of government, economy, business, and development, these satellite cities have a high opportunity to learn about good financial literacy. Even satellite cities help to meet the needs of the people of DKI Jakarta. The total population of BoDeTaBek according to the Central Statistics Agency (BPS) in 2017 was 8,348,897 people, as shown in table 1.

Table 1. Total Population of BoDeTaBek according to BPS 2017

No	Area	Total Population	Millennial Population	%
1	Bogor	1,081,009	373,621	35%
2	Depok	2,254,513	823,755	37%
3	Tangerang	2,139,891	838,500	39%
4	Bekasi	2,873,484	1,123,330	39%
TOTAL		8,348,897	3,159,206	38%

Source: BPS (2017)

## 2. Literature Review

### Millennial Generation

The term Millennial is derived from the noun cohort, which means a group of followers. In the same way that a cohort is a research group, the group in question consists of more than a few individuals who share similar characteristics. In terms of demographics, there are four cohorts: baby boomers born between 1946 and 1964, Gen-X born between 1965 and 1980, Millennials born between 1981 and 2000, and Gen-Z born between 2001 and now (Walidah, 2017). As previously stated, the millennial generation was born between 1981 and 2000, or between the ages of 18 and 37 during the research year. According to Lyons (2004), the millennial generation is more reliant on instant communication technologies such as instant messaging, e-mail, and social media. In other words, the millennial generation is the generation that was born and grew up between 1980 and 2000.

### Financial Literacy

Financial literacy is defined by the Organization for Economic Cooperation and Development (OECD) (2016) as a person's understanding and knowledge of financial concepts or risks, including skills, beliefs, and motivation in making effective financial decisions, participating in the economic sector, and improving one's financial well-being. According to the OECD (2006), a person who lacks financial literacy will be unable to select a suitable savings or investment product and will be vulnerable to fraud. Meanwhile, according to Boon et al. (2011), someone with financial literacy will be better prepared to carry out his personal financial planning. According to Huston (2010), financial literacy has two dimensions: understanding (one's personal financial knowledge and financial education) and use (the application of personal financial knowledge management).

### Locus of Control

A person's belief about an event or event that he has experienced is referred to as the locus of control (Larsen and Buss, 2002). According to Rotter (1966), there are two types of locus of control: internal locus of control and external locus of control. An individual with an internal locus of control believes that their abilities, skills, and effort have a greater influence on what they get in life. Someone with an external locus of control, on the other hand, believes that their life is influenced by forces outside of themselves, such as fate, destiny, and luck.

### Financial Knowledge

Houston (2010) defines financial knowledge as an integral dimension, but not the same as financial literacy, because financial literacy includes the confidence and ability to apply one's financial knowledge in making financial decisions, as shown in the figure 1:

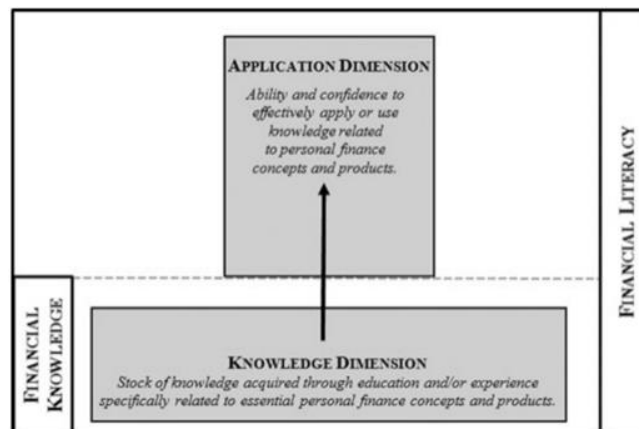

Figure 1: Concept of Financial Literacy

Source: Houston (2010)

Financial knowledge is knowledge about personal finance that an individual possesses and is one of the keys to his personal financial management behavior (Garman and Forgue in Mien and Thao, 2015). According to Mitchell and Lusardi (2015), young people who understand and understand financial knowledge have a better understanding of various financial products, financial information, and financial services than their parents.

### Financial Behaviour

According to Ricciardi (2000), financial behavior is a scientific discipline in which various disciplines interact and integrate continuously so that the discussion is not conducted in isolation. There are three factors that can influence behavioral finance, namely:

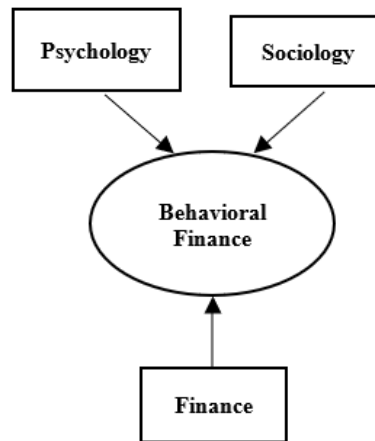

Figure 2: Behavioural Finance  
Source: Ricciardi (2000)

Figure 2 depicts the dimensions of behavioural finance, three factors influence financial behaviour: psychology, sociology, and finance. If a person wants to learn about financial behaviour, they must first understand these three aspects, which are thought to strengthen one's behavioural finance.

There is a link between financial behaviour and how a person uses his financial resources, as well as how he manages and treats his money. Someone with good financial behaviour is effective at managing his finances, such as saving money, creating a budget, controlling his desire to spend so that he does not overspend, investing, and paying his obligations on time (Nababan and Sadalia, 2012).

**Financial Attitude**

Moore argues in J.B.R (2014) that attitude is a factor that can influence a person's mind during transactions. When combined with financial knowledge and financial behaviour, attitude can help drive the outcomes of a financial decision.

According to Robbins and Judge (2015), attitude is a positive or negative evaluative statement about an event, object, or individual. In order to comprehend attitudes, we must consider their characteristics and fundamental components. The main components of attitude are cognitive, affective, and behavioural.

**3. Research Methodology**

**Data**

The data used in this study is primary data. This primary data is presented in the form of a series of questions and questionnaire statements distributed to predetermined samples. Table 2 will explain the characteristics of the research.

Table 2. Research Characteristics

No	Research Characteristics	Type
1	Method	Qualitative
2	Purpose	Verification
3	Inquiry Type	Causal
4	Research Engagement	No intervention
5	Unit Analysis	Individual
6	Data Type	Cross Section

This study employs an ordinal scale type, in which quality characteristics are ranked and a four-point Likert scale is used (Sugiyono, 2001). The table below shows the arrangement and scoring on the Likert scale.

Table 3. Likert Scale

No	Description	Score
1	Strongly Agree (SS)	4
2	Agree (S)	3
3	Disagree (TS)	2
4	Strongly Disagree (STS)	1

Source: Sugiyono (2001)

The continuum line is a line those measures, analyzes, and displays the power level of the variable being studied. According to the scale, this study employs a continuum line model with a score calculation described in the following formula:

$$\text{Interval percentage} = \frac{\text{percentage max} - \text{percentage min}}{\text{statement criteria}}$$

- The total number of respondents is 200, and the largest measurement scale value is 4, while the smallest measurement scale value is 1, so the cumulative value obtained is (200x4 = 800) and the smallest cumulative value is (200x1 = 200).
- The smallest percentage value that can be measured or calculated is: 200/800 x 100% = 25%.

To obtain the value of the range on the continuum line, namely 100% - 25% = 75%, divide it by the largest measurement scale, which is divided by 4, and the percentage interval value obtained is 18.75%. As a result, the classification criteria for the percentage assessment are as follows:



Figure 3: Continuum Line Percentage

The following is how the scores on each variable indicator in this study were calculated:

$$\text{percentage score} = \frac{\text{Total score obtained}}{\text{Total ideal score}}$$

Total score = (number of respondents who strongly agreed x 4) + (number of respondents who agreed x 3) + (respondents who disagreed x 2) + (respondents who strongly disagreed x 1).

Ideal score = number of respondents multiplied by measurement scale.

### Population and Sample

The population in this study is all millennials who live in BoDeTaBek, which has a population of 3,159,206 people (BPS, 2017). The Google form was used to distribute questionnaires to all BoDeTaBek millennial generations in this study.

Purposive Random Sampling was used in this study; the samples were chosen at random, and the criteria were determined by the researcher based on the research objectives. Thus, the sample size in research is limited by the following criteria:

- Bogor, Depok, Tangerang, and Bekasi (BoDeTaBek) residents are eligible to complete the questionnaire.
- Only people in the Millennial Generation, or those aged 18 to 37, are eligible to complete the questionnaire.

Structural Equation Modeling (SEM) will be used to analyze the data in this study. According to Slovin, the sampling used in this study was a minimum of 100 respondents to meet the criteria for the SEM model, and the data collected from the results of distributing questionnaires to the BoDeTaBek millennial generation were 200 respondents, where these results met the analysis test criteria in SEM.

#### 4. Results And Discussion

##### Reliability and validity

The questionnaire in this study must be tested for validity and reliability before further analysis. Both of these tests were performed to determine whether or not the questionnaire that had been created met the accuracy requirements. In practice, these two tests were run using the SPSS software.

If there are similarities between the data collected and the data that actually occurs in the object under study, the research results are valid (Sugiyono, 2014: 121). With a significance level of 5% and a sample size of 200, the r table is 0.139. This study was declared valid after being tested with SPSS because all of the questions in the questionnaire were t-count > r-table.

The cronbach alpha calculation technique was used to perform the study's reliability test. The minimum coefficient in the cronbach alpha calculation technique is 0.70, indicating that the questionnaire has a fairly high level of reliability. If it is less than 0.70, it indicates that the questionnaire's level of reliability is insufficient (Hair et al., 2010). As a result, with a Cronbach alpha coefficient of 0.871, this study has a fairly high level of reliability.

##### Respondent Characteristics

Respondents in this study were all members of the Millennial generation from Bogor, Depok, Tangerang, and Bekasi. The total number of respondents was 200. The following are the characteristics of the respondents as a description of the respondent's profile as a source:

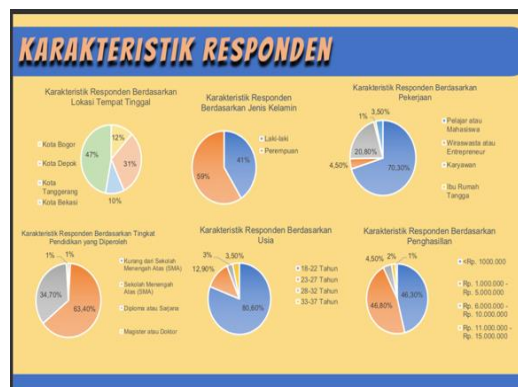

Figure 4: Characteristics Respondent

##### Financial Literacy of the BoDeTaBek Millennial Generation

Table 4 shows that the financial literacy level of the millennial generation in terms of locus of control and financial behavior variables is in the good category, namely 72.8% for locus of control, 73% for financial behavior, and 86.2% for financial attitude. The level of financial literacy as measured by a continuum line is shown below.

Table 4. Financial literacy of Millennial Generation

No	Variables	Financial Literacy Level
1	Locus of Control	72.8%
2	Financial Behaviour	73%
3	Financial Attitude	86.2%

The continuum line in Figure 5 shows that the millennial generation's locus of control is in the good category, at 72.8%. This demonstrates that the BoDeTaBek millennial generation has internalized the belief that they can control their financial problems. Financial behaviour also falls into the good category, with 73%. This demonstrates that the BoDeTaBek millennial generation has a positive attitude toward financial behaviour, which encompasses psychological, sociological, and financial factors. Meanwhile, 86.2% of people have a positive attitude toward money. The average BoDeTaBek millennial generation is very good at managing, personal budgeting, and deciding on the type of investment to be made.

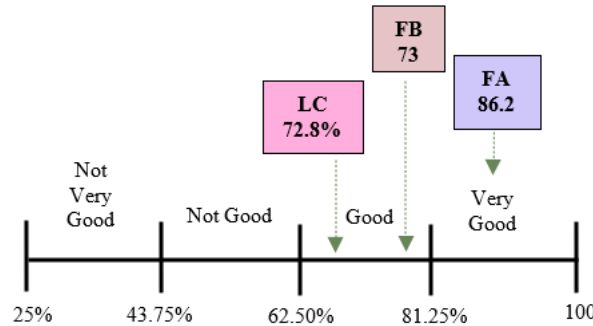

Figure 5: Millennial Generation Continuum Line by BoDeTaBek

According to table 5, the highest percentage in the financial knowledge basic category at the millennial generation's financial literacy level is classified as not good, namely 102 people or 51%, while the highest percentage in the financial knowledge advanced category at the millennial generation's financial literacy level is quite good, namely 68 people or 34%. This demonstrates that the majority of the millennial generation in Bogor, Depok, Tangerang, and Bekasi have very little knowledge of finance, as evidenced by the results obtained from basic financial knowledge and advanced financial knowledge, despite the fact that the financial knowledge advance is quite sufficient. It can be concluded that the millennial generation in Bogor, Depok, Tangerang, and Bekasi are aware of financial products but lack sufficient knowledge, implying that they require financial education.

Table 5. Based on Financial Knowledge, BoDeTaBek Millennial Generation Financial Literacy Level

No	Category	Financial Knowledge	
		Basic (%)	Advance (%)
1	Good (76%-100%)	21 (10.5%)	67 (33.5%)
2	Sufficient (56%-75%)	77 (38.5%)	68 (34%)
3	Not Good (0%-55%)	102 (51%)	65 (32.5%)
<b>Total</b>		<b>200</b>	<b>200</b>

**Confirmatory Factor Analysis (CFA) First Order**

Because LC1 is a reference variable, the LC1 indicator does not have a t-count, according to the results in table 6. If the t-count value is greater than 1.96, the variable relationship is correct. The t-count values for LC1, LC2, LC3, and LC4 are all greater than 1.96. The t-value indicates that the level of validity is good because all variables are significant.

If the loading factor value is greater than 0.50, the results are said to be fit or good. All indicators have a value greater than 0.50. This demonstrates that all indicators contribute significantly to describing the latent locus of control construct.

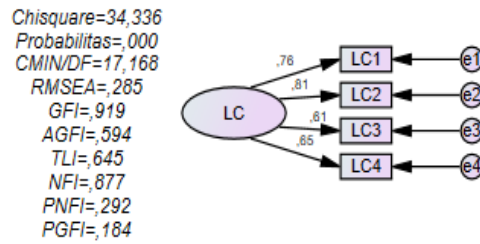

Figure 6. CFA Locus of Control  
Source: AMOS 24

Table 6. CFA Analysis Results for Locus of Control Variables Using t-values and Factor Loading

No	Variables Manifest	Loading Factor	Indicator	t-value	Indicator
1	LC1	0.763	Good	-	-
2	LC2	0.812	Good	9.601	Good
3	LC3	0.605	Good	7.753	Good
4	LC4	0.654	Good	8.347	Good

Source: Output AMOS 24

The latent locus of control construct model in table 7 is then tested for suitability as follows:

Table 7. Results of Model Conformity Testing (GOF) Latent Locus of Control Construct

Goodness of FIT Index	Cut off Value	Result	Model Evaluation
Chi-Square (df=2)	5.99	34.336	unfit
Probability (p-value)	0.05	0.000	unfit
CMIN/df	2.00	17.168	unfit
RMSEA	0.08	0.285	unfit
GFI (Goodness of Fit Index)	0.90	0.919	Fit
NFI (Normed Fit Index)	0.90	0.877	unfit
IFI	0.90	0.883	unfit
CFI (Comparative Fit Index)	0.90	0.882	unfit
TLI	0.90	0.645	unfit

Source: Output AMOS 24

The chi-square value on the locus of control variable is 34.336 with  $df = 2$ , which is 5.99146. If the obtained chi-square value is greater than the value at the cut off value, the model does not meet the ideal criteria. The p-value of 0.000, which is less than the cut-off value, indicates that the results are not fit because the resulting p-value must be greater than the cut-off value. Other GOF measures, such as CMIN/DF, RMSEA, NFI, IFI, CFI, and TLI, do not meet the criteria, indicating that they are unsuitable.

As a result, modifications must be made to obtain a fit model by covariancing or eliminating indicators that do not meet the requirements because the validity level is poor, namely LC3 and LC4. The following diagram depicts the changes that have been made:



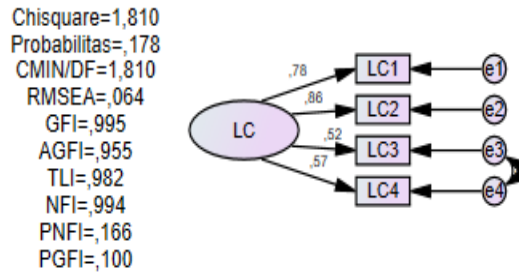

Figure 7. CFA Locus of Control Modified  
Source: AMOS 24

Following the modifications, no indicators were omitted, but the LC3 and LC4 indicators on the locus of control variable were covariance modified, and the t-value and factor loading results from the confirmatory factor analysis (CFA) are shown in table 8. According to the results in table 8, the LC1 indicator meets the criteria because the value is 1.96 higher. Because all variables are significant, the level of validity based on t-count is good. As a result, the loading factor value is greater than 0.50, indicating that the LC1 to LC4 indicators contribute significantly to describing the latent locus of control construct.

Table 8. CFA Analysis T-value and Factor Loading Results for Locus of Control Variables After Modification

Variable Manifest	Loading Factor	Indicator	t-value	Indicator
LC1	0.782	Good	-	-
LC2	0.856	Good	8.641	Good
LC3	0.518	Good	6.690	Good
LC4	0,571	Good	7.397	Good
Construct Reliability (CR) = 0.783				

Source: Output AMOS 24

The latent locus of control construct model's suitability is then tested (see table 9).

Table 9. Model Fitment Test Results (GOF) Modified Latent Locus of Control Construct

Goodness of FIT Index	Cut off Value	Result	Model Evaluation
Chi-Square (df=1)	3.84	1.810	Fit
Probability (p-value)	0.05	0.178	Fit
CMIN/df	2.00	1.810	Fit
RMSEA	0.08	0.064	Fit
GFI (Goodness Of Fit Index)	0.90	0.995	Fit
NFI (Normed Fit Index)	0.90	0.994	Fit
IFI	0.90	0.997	Fit
CFI (Comparative Fit Index)	0.90	0.997	Fit
TLI	0.90	0.982	Fit

Source: Output AMOS 24

Based on the calculation results, the chi square result for producing a goodness of fit statistics value that has been modified in the CFA model for the locus of control variable is 1.810. This indicates that the model meets the criteria because the obtained chi square value is less than the cut off value. The obtained CMIN/DF value is 1.810, which is less than the cut off value. Similarly, the RMSEA, GFI, NFI, IFI, CFI, and TLI scores all met the requirements.

### CFA Financial Behaviour

The variable financial behaviour (FB) has ten indicators as observed variables in this study. Figure 8 depicts the results of data processing for confirmatory factor analysis on financial behaviour:

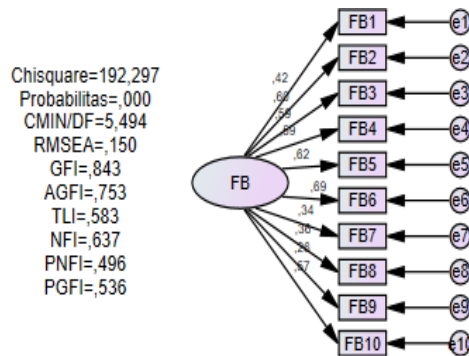

Figure 8. CFA Financial Behaviour  
Source: AMOS 24

Table 10 shows the t-value and factor load, which indicate the validity value of financial behaviour. Because FB1 is a reference variable, the indicator does not have a t-count, according to the results in table 10. The variable relationship is correct if the t-count value is greater than 1.96. Because all variables have a value greater than 1.96, the t-count results on the financial behaviour variable as a whole are considered good. This can be considered significant. Meanwhile, when the loading factor is considered, four indicators, namely FB1, FB7, and FB9, have values less than 0.50. Because these four variables have a low contribution to describing the latent construct of financial behaviour, they can be considered for elimination. The obtained Construct Reliability (CR) value was 0.777, indicating that it was more reliable than 0.70.

Table 10. Confirmatory Factor Analysis T-value and Factor Load Results for Financial Behaviour Variables

Variable Manifest	Loading Factor	Indicator	t-value	Indicator
FB1	0.419	Insufficient	-	-
FB2	0.596	Good	4.886	Good
FB3	0.589	Good	4.864	Good
FB4	0.592	Good	4.874	Good
FB5	0.617	Good	4.953	Good
FB6	0.691	Good	5.156	Good
FB7	0.342	Not Good	3.595	Good
FB8	0.361	Not Good	3.725	Good
FB9	0.258	Not Good	2.919	Good
FB10	0.572	Good	4.802	Good
Construct Reliability (CR) = 0.777				

Source: Output AMOS 24

The next step is to put the latent financial behaviour construct model in table 11 to the test:

Table 11. Latent Financial Behaviour Construct Model Conformity Test Results (GOF)

Goodness of FIT Index	Cut off Value	Result	Model Evaluation
Chi-Square (df= 35)	49,80	192,297	unfit
Probability (p-value)	0,05	0,000	unfit
CMIN/df	2,00	5,494	unfit
RMSEA	0,08	0,150	unfit
GFI (Goodness of Fit	0,90	0,843	unfit
NFI (Normed Fit Index)	0,90	0,637	unfit

IFI	0,90	0,682	unfit
CFI (Comparative Fit	0,90	0,676	unfit
TLI	0,90	0,583	unfit

Source: Output AMOS 24

Table 11 demonstrates this. The results of the financial behavior suitability trial yielded an evaluation model in which nearly all of the indicators were unfit. The chi-square value is 192.297, with a df=35 of 49.80. The obtained chi-square values are greater than the cut off value, indicating that this model does not meet the ideal criteria. Meanwhile, the resulting p-value of 0.000 is less than the cut-off value, indicating that the results do not fit because the p-value must be greater than the cut-off value. Other GOF measures, such as CMIN/DF, RMSEA, NFI, IFI, CFI, and TLI, do not meet the criteria, indicating that they are unsuitable.

As a result, it must be modified in order to obtain a fit model by removing indicators that do not meet the requirements because their validity level is low, namely indicators FB5, FB7, and FB8. Figure 9 depicts the result of the modification:

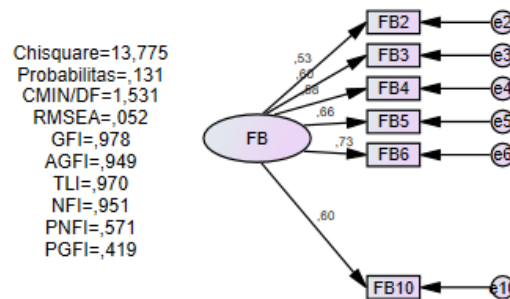

Figure 9. CFA Financial Behaviour Modified

Source: AMOS 24

Following the modification, namely the removal of the four indicators, the results of the t-value and factor loading were obtained from the confirmatory factor analysis (CFA), as shown in table 12.

Table 12. The modified t-value and CFA Result Factor Loading for the Financial Behaviour variable.

Variable Manifest	Loading Factor	Indicator	t-value	Indicator
FB2	0.529	Good	-	-
FB3	0.596	Good	5.828	Good
FB4	0.577	Good	5.716	Good
FB6	0.658	Good	6.155	Good
FB9	0.730	Good	6.452	Good
FB10	0.597	Good	5.836	Good
Construct Reliability (CR) = 0.786				

Source: Output AMOS 24

According to the results in table 12, the FB2 indicator already meets the criteria because its value is greater than 1.96. Because all variables are significant, the level of validity based on the t-value is good. The loading factor is greater than 0.50. This demonstrates that the indicators FB2, FB3, FB4, FB6, FB9, and FB10 contribute significantly to describing the latent construct of Financial Behaviour.

The latent construct GOF model Financial Behaviour is then tested for suitability (see table 13).

Table 13. Latent Financial Behavior Construct After Modification Model Conformity Test Results (GOF).

Goodness of FIT Index	Cut off Value	Result	Model Evaluation
Chi-Square (df=9)	16.92	13.775	Fit
Probability (p-value)	0.05	0.131	Fit
CMIN/df	2.00	1.531	Fit
RMSEA	0.08	0.052	Fit
GFI (Goodness Of Fit Index)	0.90	0.978	Fit
NFI (Normed Fit Index)	0.90	0.951	Fit
IFI	0.90	0.983	Fit
CFI (Comparative Fit Index)	0.90	0.982	Fit
TLI	0.90	0.970	Fit

Source: Output AMOS 24

According to the calculation results, the chi-square value to produce a goodness of fit statistics (GOF) value that has been modified in the CFA model of the financial behaviour variable is 13.775. This indicates that the model meets the criteria because the obtained chi-square value is less than the cut off value. The obtained CMIN/DF value is 1.531, which is less than the cut off value. Similarly, the RMSEA, GFI, NFI, IFI, CFI, and TLI scores all met the requirements.

### CFA Financial Attitude

The variable financial attitude (FA) has seven indicators as observed variables in this study. Figure 10 depicts the results of data processing for confirmatory factor analysis (CFA) on financial literacy.

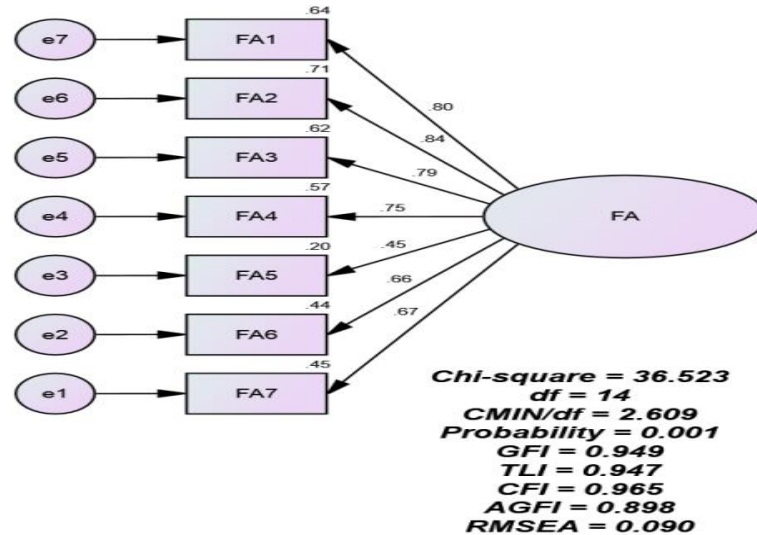

Figure 10. CFA Financial Attitude  
Source: AMOS 24

Table 14 shows the t-value and factor loading, which indicate the validity value of financial attitude.

Table 14. The Financial Attitude variable's t-value and CFA Result Factor Loading.

Variable Manifest	Loading Factor	Indicator	t-value	Indicator
FA1	0.798	Good	-	-
FA2	0.841	Good	12.964	Good
FA3	0.787	Good	11.941	Good

Variable Manifest	Loading Factor	Indicator	t-value	Indicator
FA4	0.752	Good	11.282	Good
FA5	0.449	Not Good	6.242	Good
FA6	0.662	Good	9.680	Good
FA7	0.673	Good	9.860	Good
Construct Reliability (CR) = 0.879				

Source: Output AMOS 24

According to the results of the data in table 14, the FA1 variable does not have a t-count either, because FA1 is a reference variable. According to the loading factor, one indicator, the FA5, has a value less than 0.50, indicating that the FA5 variable has a low contribution to describing the latent financial attitude construct. As a result, it can be considered for removal. Meanwhile, according to the t-count, all variables are good because their t-count is greater than 1.96. This demonstrates a significant variable. The obtained Construct Reliability (CR) value showed a reliability of 0.879. The next step is to put the GOF model of latent financial attitude to the test.

Table 15. Results of Model Conformity Testing (GOF) Construct of Latent Financial Attitude.

Goodness of FIT Index	Cut off Value	Result	Model Evaluation
Chi-Square (df= 14)	23.68	36.523	unfit
Probability (p-value)	0.05	0.000	unfit
CMIN/df	2.00	2.609	unfit
RMSEA	0.08	0.090	unfit
GFI (Goodness of Fit Index)	0.90	0.949	Fit
NFI (Normed Fit Index)	0.90	0.945	Fit
IFI	0.90	0.965	Fit
CFI (Comparative Fit Index)	0.90	0.965	Fit
TLI	0.90	0.947	Fit

Source: Output AMOS 24

Table 15 illustrates this. The results of the financial attitude suitability test (GOF) revealed that four indicators did not fit the model. The chi-square value is 36.523, and the cut off value with df = 14 is 23.68. The obtained chi-square values are greater than the cut off value, indicating that this model does not meet the ideal criteria. Meanwhile, the resulting p-value of 0.000 is less than the cut-off value, indicating that the results do not fit because the p-value must be greater than the cut-off value. Other GOF measures, such as CMIN/DF and RMSEA, do not meet the criteria, indicating that they are not yet ready.

As a result, it must be modified in order to obtain a fit model by removing indicators that do not meet the requirements because their validity level is poor, namely the FA5 indicator. Figure 11 depicts the modification results.

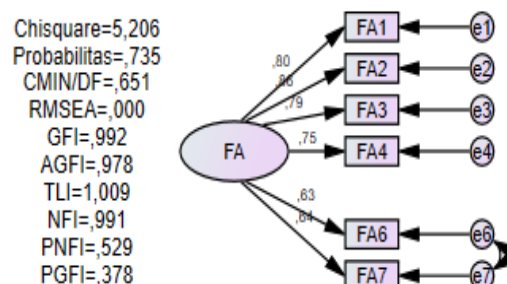

Figure 11. CFA Financial Attitude Modified

Source: AMOS 24

Following the modifications, the results of the t-value and factor loading from the confirmatory factor analysis (CFA) are shown in table 16.

Table 16. The modified t-value and CFA Result Factor Loading for the Financial Attitude variable.

Variable Manifest	Loading Factor	Indicator	t-value	Indicator
FA1	0.801	Good	-	-
FA2	0.860	Good	13.245	Good
FA3	0.790	Good	11.988	Good
FA4	0.751	Good	11.266	Good
FA6	0.629	Good	9.074	Good
FA7	0.640	Good	9.256	Good
Construct Reliability (CR) = 0.884				

Source: Output AMOS 24

Based on the results in Table 16, these indicators meet the criteria because the value is greater than 1.96. The t-value indicates that the level of validity is good because all variables are significant. The loading factor is greater than 0.50. This demonstrates that the indicators FA1, FA2, FA3, FA4, FA6, and FA7 contribute significantly to describing the latent construct of Financial Attitude.

Table 17 will then be used to test the suitability of the Financial Attitude latent construct model. The goodness of fit statistics (GOF) in the Financial Attitude variable CFA model obtained a chi-square result of 5.206 based on the calculation results in table 17. This indicates that the model meets the criteria because the obtained chi-square value is less than the cut off value. Similarly, the CMIN/DF, RMSEA, GFI, NFI, IFI, CFI, and TLI scores all met the requirements.

Table 17. Results of Model Conformity Testing (GOF) Construct of Latent Financial Attitude.

Goodness of FIT Index	Cut off Value	Result	Model Evaluation
Chi-Square (df=8)	15.51	5.206	Fit
Probability (p-value)	0.05	0.735	Fit
CMIN/df	2.00	0.651	Fit
RMSEA	0.08	0.000	Fit
GFI (Goodness Of Fit Index)	0.90	0.992	Fit
NFI (Normed Fit Index)	0.90	0.991	Fit
IFI	0.90	1.005	Fit
CFI (Comparative Fit Index)	0.90	1.000	Fit
TLI	0.90	1.009	Fit

Source: Output AMOS 24

### CFA Financial Knowledge

Because there are only two latent variables in financial knowledge, CFA testing is done using CFA 2nd order analysis. Factor loading, t value, or construct reliability cannot be used to identify CFA results for latent variables on financial knowledge. This is due to the fact that the resulting degree of freedom is negative. As a result, the latent variables on financial knowledge are estimated using CFA 2nd order.

### Estimation Results

This stage is used to determine whether the variables Locus of Control, Financial Knowledge, Financial Behaviour, and Financial Attitude can measure Financial Literacy. If the resulting t-statistics value is greater than 1.96, the Locus of Control, Financial Knowledge,

Financial Behaviour, and Financial Attitude variables are said to be capable of measuring the Financial Literacy variable. The value of  $R^2$  can be used to calculate the contribution of the variables Locus of Control, Financial Knowledge, Financial Behaviour, and Financial Attitude to measuring Financial Literacy. The results of the 2nd order Confirmatory Factor Analysis (CFA) test are as follows:

**Goodness of Fit (GOF)**

The measurement model and the structural parameter model are estimated together in the SEM model and must meet the demands of a fit model, so the model must be based on a strong theory. Table 18 shows the estimation results and fit model of a one-step approach to SEM using the AMOS 24 application program.

Table 18 demonstrates that no goodness of fit criteria have met the cut off value. As a result, this model will be modified (see Figure 12).

Table 18. Goodness of Fit (GOF) Results

Criteria	Hasil	Cut-off Value	Model Evaluation
$X^2$ - Chi Square	398.105	124.34	unfit
Probability	0.000	$\geq 0.05$	unfit
CMIN/DF	3.039	$\leq 2.00$	unfit
RMSEA	0.101	$\leq 0.08$	unfit
GFI	0.839	$\geq 0.90$	Marginal Fit
AGFI	0.790	$\geq 0.90$	unfit
IFI	0.818	$\geq 0.90$	Marginal Fit
TLI	0.784	$\geq 0.90$	Marginal Fit
CFI	0.815	$\geq 0.90$	Marginal Fit

Source: Output AMOS 24

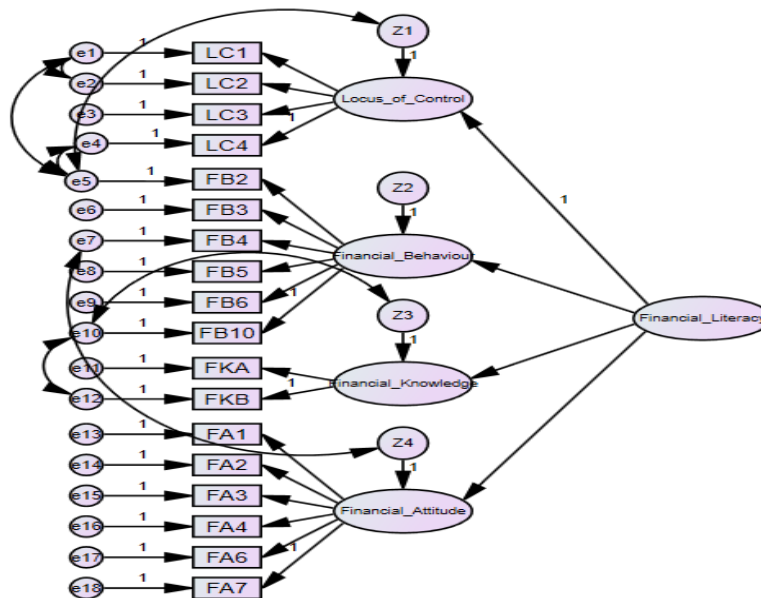

Figure 12. GOF Modified  
Source: AMOS 24

Table 19. Goodness of Fit (GOF) Result after Modification Indices

Criteria	Result	Cut-off Value	Model Evaluation
$X^2$ - Chi Square	139,254	Expected to be small	Good Fit
Probability	0.165	$\geq 0.05$	Good Fit
CMIN/DF	1.123	$\leq 2.00$	Good Fit

Criteria	Result	Cut-off Value	Model Evaluation
RMSEA	0.025	$\leq 0.08$	Good Fit
GFI	0.928	$\geq 0.90$	Good Fit
AGFI	0.900	$\geq 0.90$	Good Fit
IFI	0.990	$\geq 0.90$	Good Fit
TLI	0.987	$\geq 0.90$	Good Fit
CFI	0.989	$\geq 0.90$	Good Fit

Source: Output AMOS 24

Table 19 shows that all of the goodness of fit criteria met the cut off value, indicating that the evaluation results indicate a good model. This explains why the model used in this study yields the expected level of accuracy. As a result, this model is a good and feasible model for explaining the model's interrelationships.

**Hypothesis test**

The results of hypothesis testing after most of the goodness of fit criteria are met are as follows. As a result, the magnitude of each factor's coefficient is more reliable, as seen in the causality test in the table below.

Table 20. Hypothesis Test

Variable	Estimate	C.R.	Loading Factor	R <sup>2</sup>
Locus of Control	1.000	-	0.747	0.558
Financial Behaviour	0.732	4.522	0.681	0.464
Financial Knowledge	-0.065	-0.544	-0.012	0.000
Financial Attitude	0.567	3.709	0.524	0.274

Source: Output AMOS 24

Based on table 20, the interpretations as follows:

- a. Locus of Control is a reference variable, it has no t-value. The loading factor value is known to be 0.747. When the number is greater than 0.5. As a result, the Locus of Control can be used to accurately measure the Financial Literacy variable. The calculated R<sup>2</sup> value is 0.558. This means that Locus of Control accounts for 55.8% of the variance in Financial Literacy. As a result, hypothesis 1 can be stated to be true.
- b. Financial Knowledge yields a t-value of -0.544. This number is less than 1.96. This demonstrates that Financial Knowledge is ineffective at measuring the Financial Literacy variable. -0.012 is the loading factor value. When the value is less than 0.5. As a result, it can be concluded that Financial Knowledge does not accurately measure the Financial Literacy variable. The final R<sup>2</sup> value is 0.000. This means that Financial Knowledge cannot contribute to the measurement of the Financial Literacy variable. As a result, hypothesis 3 cannot be satisfied.
- c. The t-value for Financial Behaviour is 4.522. This value is higher than 1.96. This demonstrates that Financial Behaviour can accurately measure the Financial Literacy variable. The loading factor is equal to 0.687. When the number is greater than 0.5. As a result, it can be concluded that Financial Behaviour has a strong ability to measure the Financial Literacy variable. The calculated R<sup>2</sup> value is 0.464. This means that Financial Behaviour accounts for 46.4% of the variance in Financial Literacy. As a result, hypothesis 2 can be stated to be true.
- d. The t-value for Financial Attitude is 3.709. This value is higher than 1.96. This demonstrates that Financial Attitude can accurately measure the Financial Literacy variable. The loading factor is equal to 0.524. When the number is greater than 0.5. As a result, it can be concluded that Financial Attitude has a strong ability to measure the



Financial Literacy variable. The calculated  $R^2$  value is 0.274. This means that Financial Attitude accounts for 27.4% of the variance in Financial Literacy. As a result, hypothesis 4 can be stated to be true.

## 5. Conclusions

The results of the Structural Equation Modelling (SEM) test using second order Confirmatory Factor Analysis (CFA 2<sup>nd</sup> Order) to determine whether the millennial generation's locus of control, financial knowledge, financial behavior, and financial attitude toward financial literacy in Bogor, Depok, Tangerang, and Bekasi cities (BoDeTaBek). According to the results of the hypothesis testing, locus of control is capable of measuring the financial literacy of the BoDeTaBek millennial generation, whereas financial knowledge is incapable of measuring financial literacy, indicating that the knowledge possessed by the BoDeTaBek millennial generation is still lacking. This condition is caused by a lack of education and socialization provided by financial institutions and the government; financial behaviour can be used to assess the financial literacy of the BoDeTaBek millennial generation; and financial attitude has contributed to or can be used to assess the financial literacy of the BoDeTaBek millennial generation.

The locus of control variable made a significant contribution in this study, as evidenced by the  $R^2$  value of 0.558, which was greater than the other variables. Meanwhile, the LC2 statement (I can control myself over the financial problems that I face in everyday life) is a locus of control indicator that can measure the level of financial literacy among the millennial generation.

## References

- Badan Pusat Statistik. (2017) "Bank dan Kantor Bank, 2010-2017", <https://www.bps.go.id/stactable/2015/09/28/1856/bank-dan-kantor-bank-2010-2017.html>. Diakses tanggal 25 Juni 2018.
- Badan Pusat Statistik Kota Bekasi. (2017). "Jumlah Jiwa Menurut Kelompok Umur dan Jenis Kelamin". <https://bekasikota.bps.go.id>.
- Badan Pusat Statistik Kota Bogor. (2017). "Jumlah Penduduk Menurut Kelompok Umur dan Jenis Kelamin" <https://bogorkota.bps.go.id>.
- Badan Pusat Statistik Kota Depok. (2017). "Jumlah Penduduk Menurut Kelompok Umur dan Jenis Kelamin". <https://depokkota.bps.go.id>.
- Badan Pusat Statistik Kota Tangerang. (2017). "Jumlah Penduduk Menurut Kelompok Umur dan Jenis Kelamin". <https://tangerangkab.bps.go.id>.
- Boon, et.al. (2011). *Financial Literacy and Personal Financial Planning in Klang Valley, Malaysia*. International Journal of Economics and Management, 149-168.
- Hair Jr, J. F., Black, W. C., Babin, B. J., & Anderson, R. E. (2010). *Multivariate Data Analysis: Seven Edition*. (pp. 758).
- Houston. (2010). *Measuring Financial Literacy*. The Journal of Consumer Affairs, 44 (2).
- Jasindo. (2017). "Pentingnya Literasi Keuangan" <https://www.jasindo.co.id/media/artikel/pentingnya-literasi-keuangan>. Diakses tanggal 3 Agustus 2017.
- J.B.R., Subarna, Bir. (2014). "Economic Literature Knowledge, Attitude and their Effect on the Recently Graduated Employees". Financial Management Practices and Satisfaction, Vol.12, 69-81.
- Larsen, R. J., Buss, D. M., (2002). *Personality psychology: Domains of Knowledge About Human Nature*. (Internatioal Edition), The McGraw-Hill, New York.
- Lyons, S. (2004). *An Exploration of Generational Value in Life and at Work*. Proquest Dissertations and Theses, 441-441.

- Mien, N. T. N., dan Thao, T. P. (2015). *Factors Affecting Personal Financial Management Behaviours: Evidence from Vietnam*. Danang: Proceedings of The Second Asia-Pacific Conference on Global Business, Economics, Finance and Social Sciences.
- Mitchell, O. S. & Lusardi, A. (2015). *Financial Literacy and Economic Outcomes: Evidence and Policy Implications*. *The Journal of Retirement*. 3(1), 107–114.
- Nababan, Darma dan Sadalia, Isfenti. (2012). “Analisis *Personal Financial Literacy dan Financial Behaviour* Mahasiswa Strata-1”. Fakultas Ekonomi Universitas Sumatra Utara.
- OECD. (2006). *The Importance of Financial Education*. Diakses dari <http://www.oecd.org/finance/financial-education/37087833.pdf>.
- OECD. (2016). *PISA 2015. Assessment and Analytical Framework: Science, Reading, Mathematic and Financial Literacy*, PISA, OECD Publishing, Paris.
- Ricciardi, V., Simon, H. K. (2000). *What is Behavioral Finance?* Business, Education and Techology Journal Fall 2000.
- Robbins, P.S., dan Judge, A.T, (2015), *Perilaku Organisasi*. Salemba Empat, Jakarta.
- Rotter, Julian B. (1996). *Generalized Expectancies for Internal Versus External Control of Reinforcement*. *Psychology Monographs*, 80,1.
- Sequis. (2017). Pentingnya Literasi keuangan Untuk Generasi Milenial. <https://otomotif.antaranews.com/berita/669449/pentingnya-literasi-keuangan-untuk-generasi-milenial>. Diakses tanggal 7 Desember 2017.
- Stabilitas. (2014). “Keuangan dan Peran Bank” <http://stabilitas.co.id/home/detail/literasi-keuangan-dan-peran-bank>. Diakses tanggal 6 November 2014.
- Sugiyono, (2001). *Metode Penelitian*. Bandung: CV Alfa Beta.
- Sugiyono. (2014). *Metode Penelitian Kombinasi (Mixed Methods)*. Bandung: Alfabeta.
- Walidah. (2017). “Tabayyun Di Era Generasi Millennial”. *Jurnal living Hadis*. Vol.2 No. 1. p-ISSN: 2528-756, e-ISSN: 2548-4761.